

Plinth | Medical



Multi-Purpose Chair

Models: 93MP & 93MPT

USER MANUAL

Contents

1. Introduction	3
General Warnings	3
2. Installation	4
Retractable Castors	4
Adjustable Foot	4
Power Supply	5
Lifting and Moving	5
3. General Operation	6
Electric Operation	6
Manual Head & Foot Sections	7
Castor Operation	7
Armrest Operation	8
4. Accessories Operation	9
Paper Roll Holder	9
Battery Backup	9
Fold Down Cot Sides	10
IV Pole	10
Footswitch	11
5. Cleaning and Decontamination	12
6. Troubleshooting	13
7. Maintenance	14
8. Guarantee and Service	15
9. Technical Specification	16
10. Revisions to Manual	17

Plinth Medical Ltd is an ISO Audited company to ISO9001:2008



Our products are CE marked in conformity with the EC Directive MDD 93/42/EEC

1. Introduction

Thank you for purchasing a product from Plinth Medical Ltd. We use the highest quality components and manufacturing techniques to ensure that our products are simple to use and will last a long time. It is recommended that all users read and retain this User Manual for reference.

Throughout this manual notice is made of a Warning and Caution system to highlight to the user practices, procedures or conditions that should either not be allowed to happen or happen with caution.

Warnings are in a box with bold type and identify potential hazards, procedures or conditions which could result in death, injury or serious damage.

Cautions are in a box with plain type and identify conditions or procedures where if caution is not taken it may result in damage or failure of equipment.

General Warnings

WARNING

Maximum Load (SWL) is 250kg distributed evenly.

Do not use flammable gasses in proximity to an electrically operated chair.

Do not concentrate weight on either side or either end of the chair.

Use only accessories approved for use with this chair.

Disconnect power supply before moving chair.

Children must be adequately supervised in the presence of the chair.

Do not allow children to play with the chair at any time.

2. Installation

Although this chair comes complete and is virtually ready to use it is important to remove all packaging and read the following before use.

Retractable Castors

The castors can be operated from either side of either end of the chair. Press the pedal down to engage the castors and lift the pedal to retract the castors.

Please refer to the Operation section on page 7 for further details.

WARNING

Castors must be retracted before the chair is used and whilst patients get on or off the chair.

Care should be taken to ensure patients do not trip over any part of the chair when getting off.

Adjustable Foot

Fitted to the head end of the chair is an adjustable foot. This is designed to stabilise the chair and must be set before use. The foot should be wound in/out until it is firmly in contact with the floor whilst the castors are retracted. Check that the chair is firm and stable and then adjust the lock nut back up against the chair leg to lock the adjustable foot in position. Incorrect adjustment will result in the chair being unstable and the wheel pedals difficult to operate.

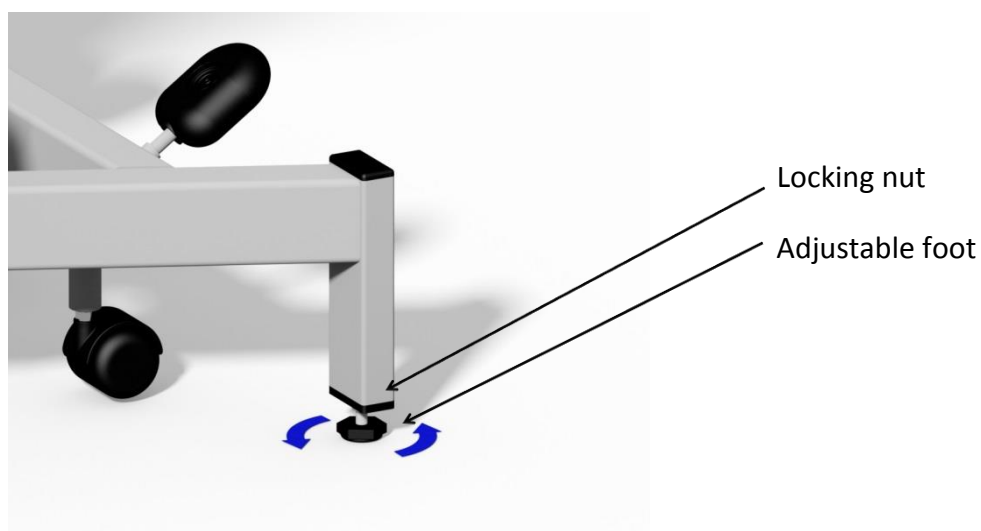

Power Supply

Ensure that hand or foot switch leads are clear of the moving parts of the chair before operation. Connect the chair to a normal domestic type power supply observing the following notes.

WARNING

Ensure that the mains lead, plug and socket are in good condition before connecting the equipment.

Ensure that the mains cable has a clear run and is not stretched when connected and that no one can fall over the cable.

CAUTION

When chair is not in use switch off power supply.

Lifting and Moving

Should the chair need to be moved or lifted (for example to remove it from its packaging) then a minimum of two people are required. The chair must only be lifted by the metal base frame near the wheels. If the chair is upside down then it may be carried by holding it underneath the upholstery. When turning the chair over, please make sure the frame and upholstery are supported at all times, otherwise damage may occur to the upholstery and gas springs.

CAUTION

Under no circumstances lift the chair by the upholstery or top sections as damage will occur to the gas spring mechanisms.

3. Operation

Plinth Medical offers 2 models of Multi-Purpose Chair; 93MP (single motor chair) and 93MPT (tilting two motor chair). Depending on the model you have some of the following features may not be present.

Electrical Operation General

WARNING

Safely position patient before operating any functions.

Position the switch in a place where it is clear of the moving parts of the chair and where accidental operation is not possible.

Ensure that all electrical cables are clear of the moving parts of the chair.

Electrical Operation (hand)

A standard fitment to the Multi-Purpose chair is a single hand control able to operate all electrical functions.

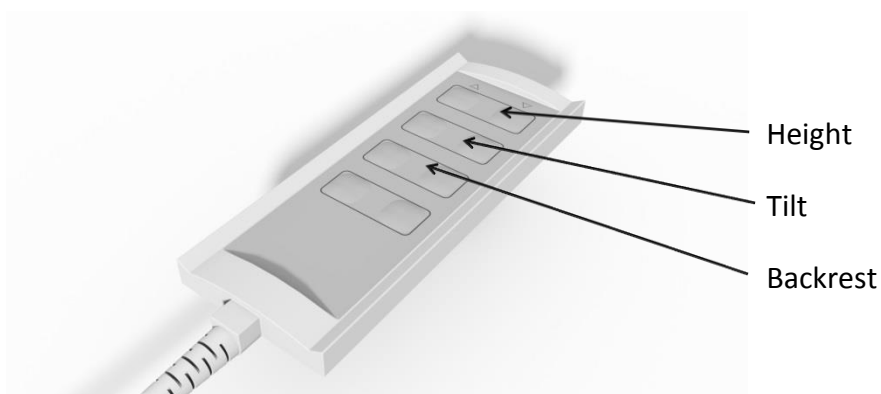

Electrical Operation (foot)

As an option this chair may be supplied with a foot switch to operate the electrical functions. It will operate in the same way as the hand switch but must be placed on the floor and operated by foot.

Manual Head Sections

For versions that do not have a motorised head section. The operation is via a gas spring mechanism triggered with a lever as shown below:

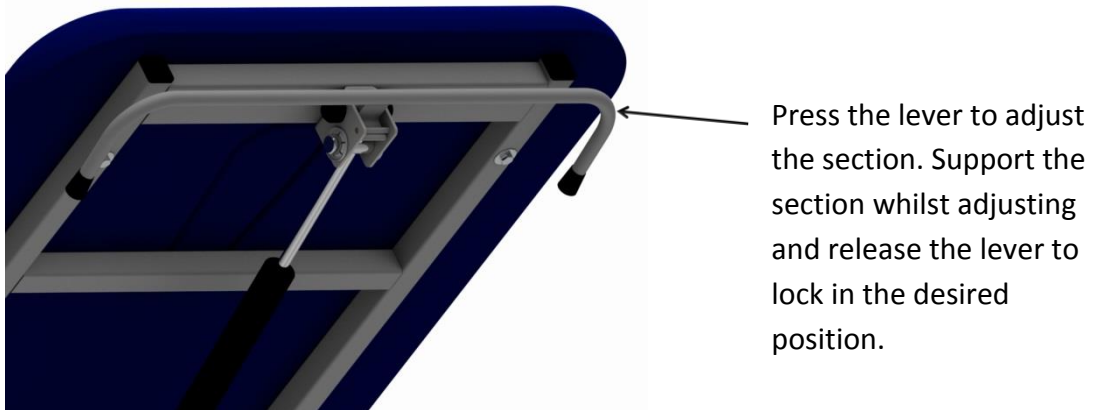

Retractable Castor Operation

The castors fitted to this chair are 50mm retractable swivel castors. They are operated in pairs at each end of the chair via the black wheel pedals.

NOTE – the castors are not designed for patient transport.

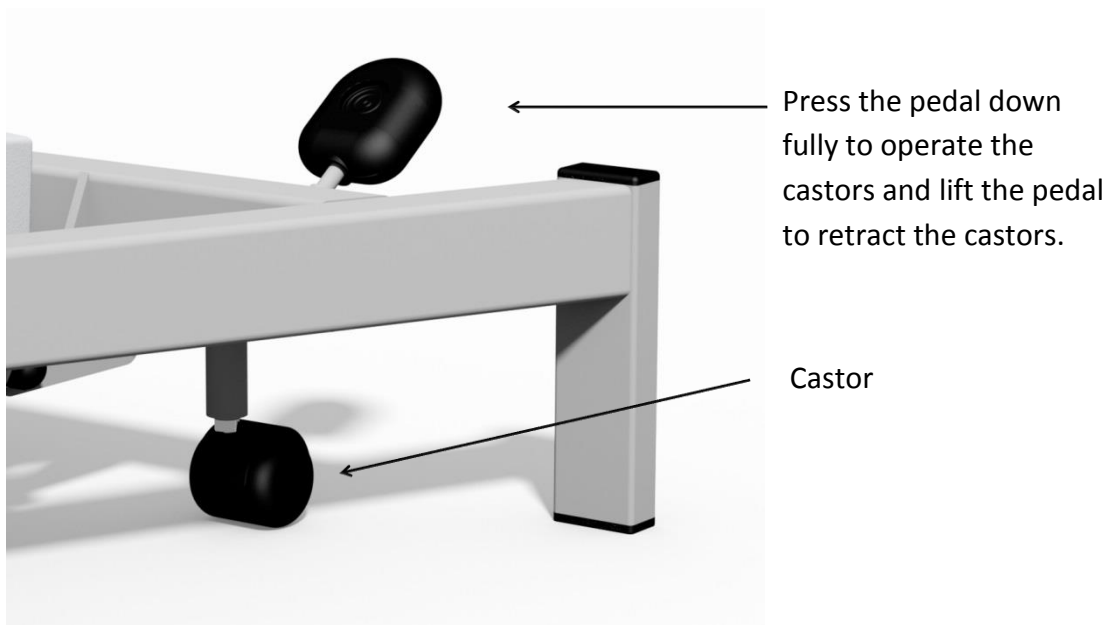

WARNING

Castors must be retracted before the chair is used and whilst patients get on or off. Disconnect and coil electrical leads and switch away from the chair mechanism prior to moving the chair.

Armrest Operation

The chair is supplied as standard with a pair of Phlebotomy arms. These are adjustable as follows:

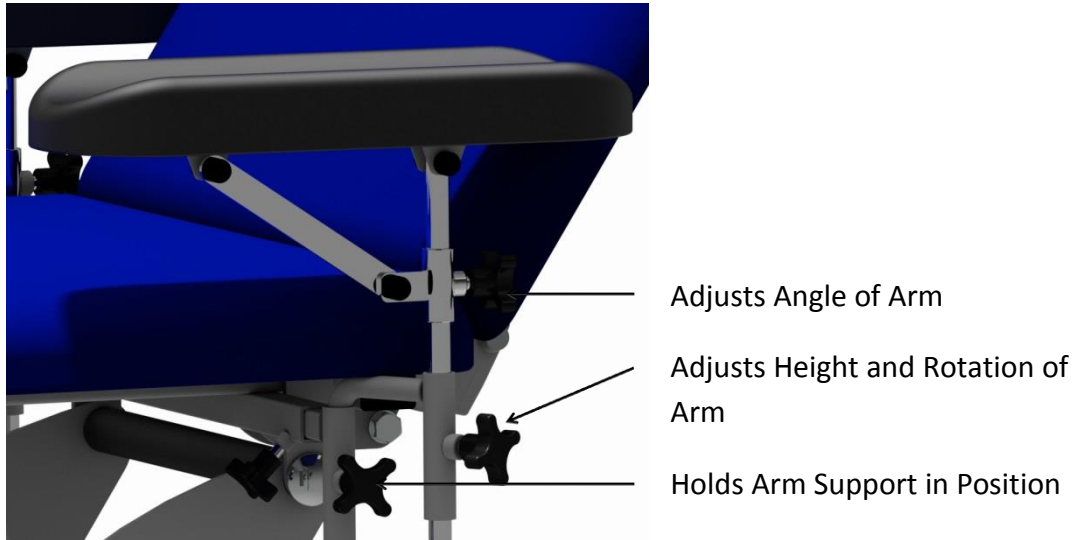

WARNING

The armrests must be locked properly whilst in use.

Do not insert or remove needles from the donor/patient unless the armrest has been verified as securely positioned.

4. Accessories Operation

A range of accessories are available as options to expand the use of the chair. The standard recommended accessories are detailed below. Many of these can be fitted retrospectively if required.

Paper Roll Holder

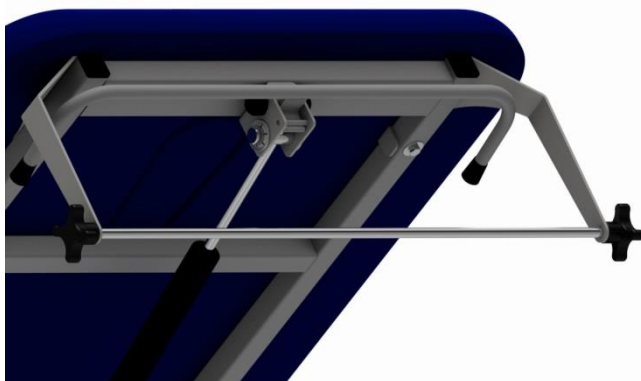

Paper roll is replaced by removal of one or the other of the plastic knobs, sliding the bar partially through the leg of the holder and then fitting the tube over the bar. Re fit in the reverse order.

Battery Backup

Battery backup is a useful option in case of power shortages. It allows at least one full cycle under battery power to enable the patient to get off the chair. If specified with the chair then this feature will remain automatically charged and ready for use in the event of a power failure.

CAUTION

Do not use the battery to operate the chair other than for one cycle. This feature is designed to get a patient off the chair in an emergency and frequent use will destroy the battery.

Battery operation is available as an option if required.

Fold Down Cot Sides

Fold down cot sides are available as an option and may only be used with the Multi-Purpose armrests removed. They are operated as follows:



To raise the cot side from the down position; lift and rotate the cot side towards you through a full 180°. When upright push the cot side down into the plastic block until it is fully located.

To lower the cot side from the upright position; lift up in the plastic block and then rotate a full 180° into the down position.

WARNING

Ensure that the cot side is fully engaged in the plastic block whilst in use.

IV Pole



Adjust the IV pole position to suit the patient by unlocking the locking thumbwheel, adjust the position of the pole and tighten the thumbwheel.

Footswitch

An optional fitment footswitch may be specified for the chair and will look similar to the one pictured below. Note that the switch will vary depending on the model of chair and the number of motors fitted. The example below is for the 3 motor chair.

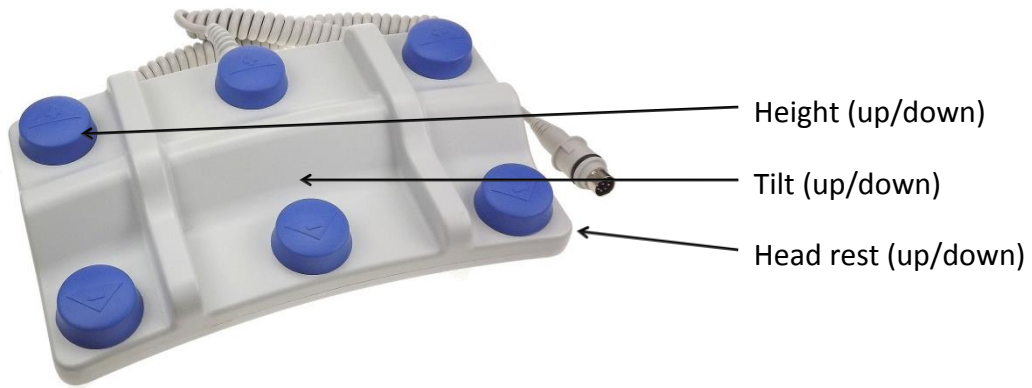

For chairs fitted with four motors the sequence shown above will remain with the fourth row of buttons operating the Foot rest.

5. Cleaning and Decontamination

WARNING

If contamination is suspected then decontaminate the chair before use.

Torn or damaged upholstery should be replaced immediately.

CAUTION

Do not use Alkalis or other organic solvents for routine cleaning.

Always cover the vinyl with paper towelling or chair covers if it can come into contact with bare skin.

Cleaning

Always wear suitable protective clothing before carrying out this procedure. Disconnect the mains supply to the chair and move it to a suitable cleaning area and lock the castors.

Step 1. Using warm water and soap on a damp cloth, carefully wipe the chair over from top to bottom. Take great care around electrical components.

Step 2. Wipe the chair carefully from top to bottom using a clean damp cloth and soap free water.

Step 3. Carefully dry the chair from top to bottom with clean lint free paper towels.

Decontamination

To decontaminate the chair repeat the above steps but using a dilute solution of Hypochlorite and warm water (10,000ppm) instead of warm water and soap. At the end of the procedure discard all cleaning materials in a safe manner and wash hands thoroughly.

6. Troubleshooting

In the unlikely event of the chair failing to operate and having carried out the normal practical fault finding steps below then please contact our Customer Service Team on +44 (0)1449 767887 or email customerservice@plinthMedical.com. **Please have the serial number to hand before making contact so we can help you more efficiently.**

Fault	Possible Cause	Remedy
Chair is unstable	Uneven floor	Move chair to flat floor
	Adjustable foot	Check presence, condition and adjustment of foot
All motors will not work (93MP the only motor will not work)	Power disconnected	Connect power supply
	Fuse Blown	Replace fuse in plug
	Hand/ Footswitch disconnected	Check the switch is fully connected to the motor
One motor will not work but others working (93MPT)	Lead from height motor/control box not connected to slave motor	Check and connect all leads
	Fault with switch	Replace switch
	Fault with control box	Replace control box
Motor sinks	Fault with motor	Replace motor
	Switch permanently operated	Unplug and re-connect switch
	Motor fault	Replace motor
Backrest or footrest will not work (manual versions)	Gas spring incorrectly adjusted (not being triggered)	Rotate gas spring until the pin is just in contact with the lever (2-3mm play required)
	Gas spring faulty	Replace gas spring
Backrest or footrest sinks under load (manual versions)	Gas spring incorrectly adjusted (permanently triggered)	Rotate gas spring until the pin is just in contact with the lever (2-3mm play required)
Armrests slip or are loose	Locking thumbwheels not correctly tightened	Correctly tighten locking thumbwheels
		Replace thumbwheels

	Thumbwheels damaged from over tightening	
--	--	--

7. Maintenance

Plinth Medical Ltd products are designed to be maintenance free. However keeping your Plinth products clean and regularly checked will assist in prolonging their working life. The following is a guide of simple checks that the user can carry out on a six monthly basis. We would also recommend an annual service visit by a Plinth Medical trained engineer.

WARNING

Disconnect chair from electrical supply before commencing any of the following checks.

Examine the chair for any signs of damage. Pay particular attention to all nuts, bolts and fasteners to check they are present and tight but not over tight.

Upholstery bolts should all be checked (each section has between 2 and 6 No. M6 bolts), they should all be present and tight.

Check gas struts (if fitted) and ensure that they operate through the full range of movement and lock fully.

Check hinge pins are lubricated and not rusty.

Check main chair nylon pivot bearings are lubricated sufficiently.

Examine mains and switch cables for any damage, cuts, kinks, abrasions etc. These must be replaced if necessary.

Check mains lead, switch cables and slave motor leads are all correctly and securely attached.

Check correct plug fuse is fitted (5A).

WARNING

Any electrical checks or work other than the visual inspection above must be performed by a qualified electrician.

Do not connect BLUE or BROWN wires to the earth terminal of a plug.

8. Guarantee and Service (UK only)

Plinth Medical Ltd offer a 5 year parts guarantee on all Premium Range products delivered from January 2013 and a lifetime frame guarantee. The only exclusion to this guarantee is for negligent damage or damage to upholstery coverings. This guarantee does not require registration of the product as we can trace it from its serial number, however in the event of the serial number being removed, missing or unreadable then this may void the guarantee. These terms do not affect your statutory rights.

In addition to the above Plinth Medical Ltd can offer both extended warranties and service contracts. For further information about either of these please contact:

Customer Service
Plinth Medical
Barric Lane
Occold
Eye
Suffolk
IP23 7PX
Tel: 01449 767887
Mail: customerservice@plinthMedical.com

In the event of returning a product or part to us then please follow the instructions for cleaning under section 5 before enclosing it in suitable packaging and returning it to the above address. In addition please ensure there is a statement confirming that it has been decontaminated and what the fault is along with relevant contact details.

Worldwide

Please contact the distributor you purchased the chair from for service and support in your country. If you are unable to do so then please contact us in the UK and we will refer you to our local representative.

9. Technical Specifications

	93MP	93MPT
Head Length (cm)	81	81
Seat Length (cm)	50	50
Foot Length (cm)	44	44
Width (cm)	63	63
Overall Length (cm)	179	179
Height Range (cm)	53-100	53-100
Max Working Load	250kg	250kg
Control	Hand switch	Hand switch
Motor(s)	Linak LA31 x 1	Linak LA31 x 2
Control Box	Linak CB09	Linak CB09
Current	1.5A	1.5A
Power	360W	360W
Mains Plug Fuse	5.0A x 1	5.0A x 1
Internal Fuse	1.5A x 1	1.5A x 1
System Voltage	24v	24v
IP Rating	IPX4	IPX4
Motor(s)	Linak LA31 x 1	Linak LA31 x 2
Control Box	Linak CB09	Linak CB09
Current	2.7A	2.7A
Power	360W	360W
Mains Plug Fuse	5.0A x 1	5.0A x 1
Internal Fuse	3.0A x 1	3.0A x 1
System Voltage	24v	24v
IP Rating	IPX4	IPX4

IEC 601-1 Electrical Safety Classification

All models are double insulated Type B equipment and marked as such.

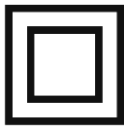

Double Insulated



Type B Equipment

10.Revisions to Manual

Pages	Issue No	Name	Date
All	Manual – 01	Martin Lankester	13.06.2017

Plinth Medical

Barric Lane

Occold

Eye

Suffolk

IP23 7PX

ENGLAND

Plinth Medical Ltd In association with Plinth 2000 are an ISO Audited company to
ISO9001:2008



Our products are CE marked in conformity with the EC Directive MDD 93/42/EEC